



PRINT HEADS FOR VISCOUS FLUIDS & PASTES

SOLUTIONS FOR YOUR EXTRUSION
BASED ADDITIVE MANUFACTURING





MATERIALS

1-COMPONENT MATERIALS



A selection of possible materials:

- Silicones
- Abrasive pastes
- Waxes
- Acrylates
- Biotechnical suspensions
- High performance & technical ceramics
- UV adhesives, Grease, Inks, Polyester resins, etc.

2-COMPONENT MATERIALS



A selection of possible materials:

- Epoxy resins
- Acrylates
- Silicones
- Polyurethanes, Polyester resins, etc.



TECHNOLOGY USING THE ENDLESS PISTON PRINCIPLE

ADDED VALUE FOR THE CUSTOMER

Thanks to our technology, a wide range of liquid and pasty materials can be used for additive manufacturing, including highly viscous materials.

Due to the linear behavior of speed to dispensing volume, we achieve very high precision and a repeatability of up to 99 % even with these materials. The printing process is additionally improved by the active suck-back – no more dripping!

OUR TECHNOLOGY

Volumetric dispensing and filling systems are based on the ENDLESS PISTON PRINCIPLE and are used in low to high viscosity fluids.

At the heart of each application is a progressive cavity pump which is purely volumetrically fed. The interaction between the rotor and the stator results in a feeding and dosing characteristic which is the same as an endlessly moving piston.

This results in a pressure-stable linear pump characteristic curve. It allows a clear statement about the ratio of revolution, time and dosed volume. Therefore, a constant volume can be dosed either via the time function or via the number of revolutions function, and give a dosing accuracy at the pump outlet of $\pm 1\%$ (depending on the material) or less.





1-COMPONENT PRINT HEAD

The print head impresses with its unique precision and is suitable for nearly all 1-component fluids. (higher printing speed with vipro-HEAD 5)



MOTOR

- Control via stepper motor signals (24 V) or Step/Direction-Signale (3.3 V/5V)
- Compact design with parallel arrangement of the individual motors

MATERIAL SUPPLY & BLEEDING SCREW

- Easy product handling
- Optional bleeding screw for easy bleeding

ENDLESS PISTON PRINCIPLE

- Continuous printing
- High precision printing results also for heated materials

MONITORING & MOUNTING

- Optional monitoring via pressure sensor (material inlet and outlet)
- Different mounting opportunities to connect the print head with 3D printers

| Technical data | vipro-HEAD 3 | vipro-HEAD 5 |
|----------------------------------|--------------|--------------|
| Theoretical volume flow (ml/min) | 0.03 to 3.3 | 0.05 to 6.0 |
| Weight (g) | approx. 750 | approx. 750 |



2-COMPONENT PRINT HEAD

The fluids and pastes are conveyed volumetrically and separately from each other into the static mixer. The desired mixing ratio can be adjusted via the speed ratio of the drive units.



| Technical data | vipro-HEAD 3/3 | vipro-HEAD 5/5 |
|---|----------------|----------------|
| Theoretical volume flow per print head (ml/min) | 0.03 to 3.3 | 0.05 to 6.0 |
| Weight (g) | approx. 1100 | approx. 1100 |



HEATING FUNCTION FOR 1K-PRINTING

CARTRIDGE HEATER

- Capacity of 55 ml
- Fixation with a mounting plate on the print head

CARTRIDGE ADAPTER & BLEEDING SCREW

- Easy bleeding after each cartridge replacement
- Optimum heat distribution in the print head and product material

HEATING UNIT FOR PRINT HEAD

- Heating of viscous fluids and pastes
- Heatable up to 70 °C (158 °F)

DISPENSING NEEDLES

- Optimum heat distribution due to metal needles
- A wide range of dosing needles available

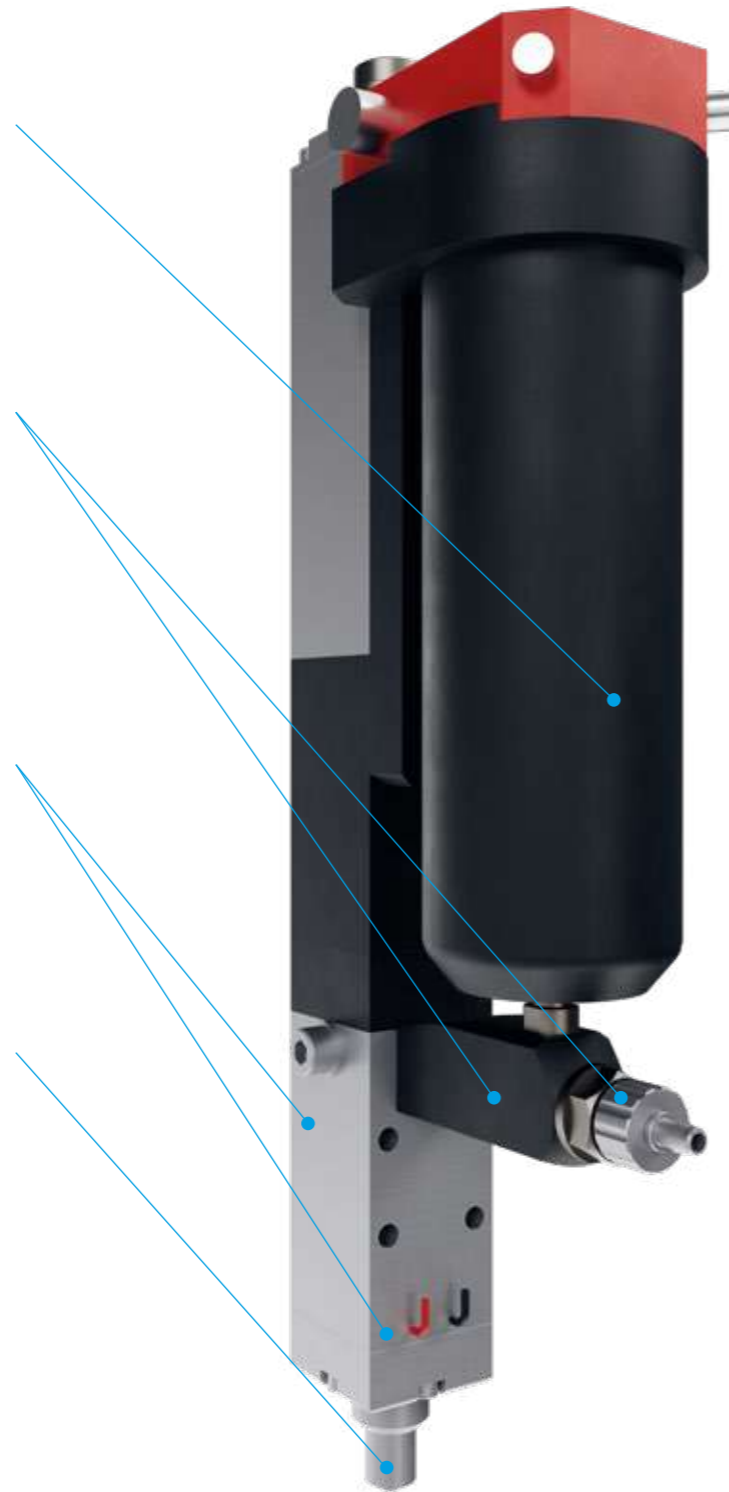

ADDITIVE DELIVERY SYSTEM VIPRO-HEAD COLOR

SUPPLY OF FLUID VIA CARTRIDGE

- Color (e.g. LSR color masterbatch)
- Additive (e.g. for changing the mechanical properties)

COLOR INFEEED INSIDE OF ADAPTER

- Perfect supply by dispensing into the center of the volume flow
- Precise supply of 1 to 3 % color into material flow
- Homogeneous color infeed leads to constant color fidelity

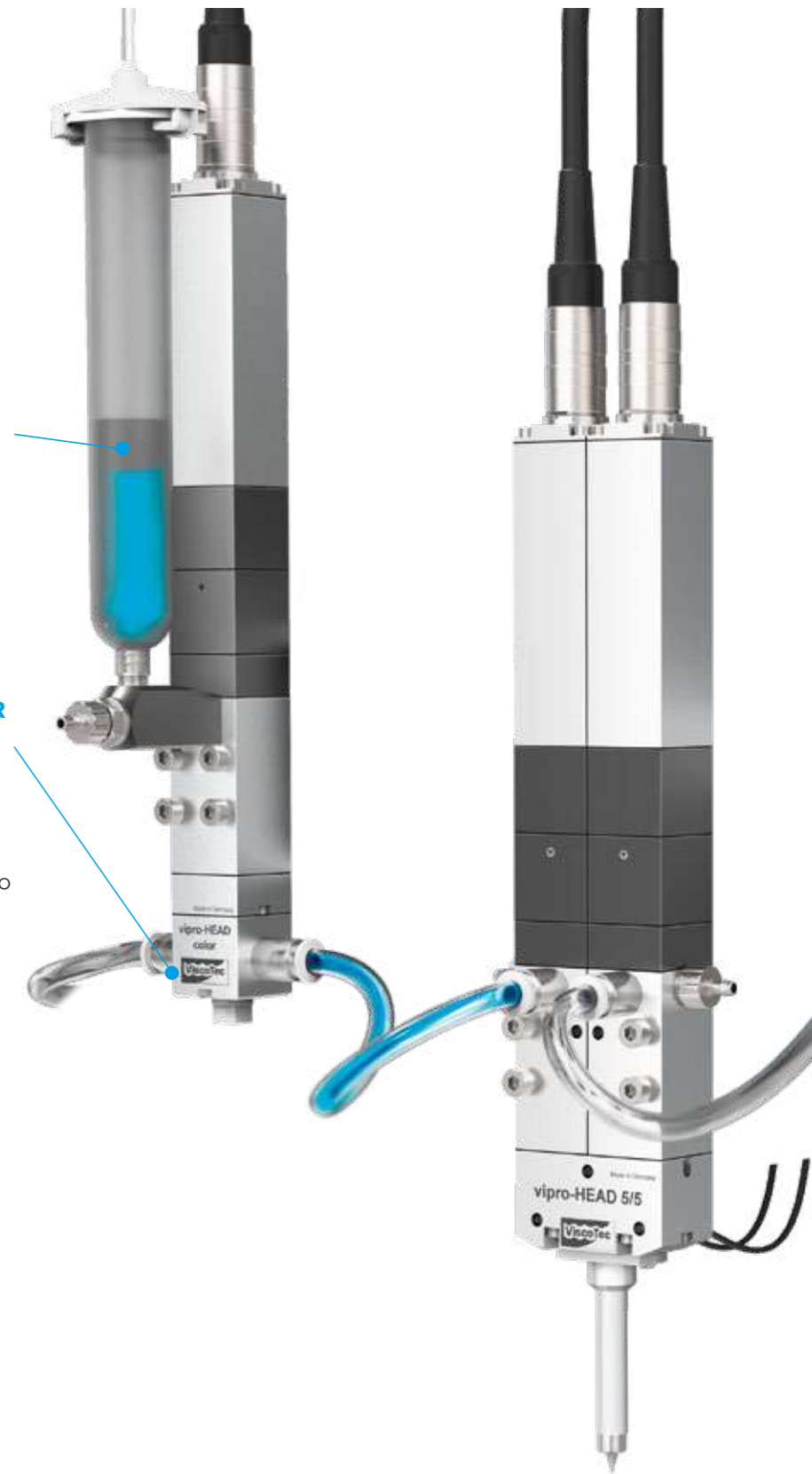



INTEGRATION IN 3D-PRINTER

EASY INTEGRATION INTO MOST EXISTING PRINTERS

- Easy mounting to existing 3d printers
- Control via G-Code
- Usage of most common slicers
- Possibility to monitor the printing process through pressure sensors

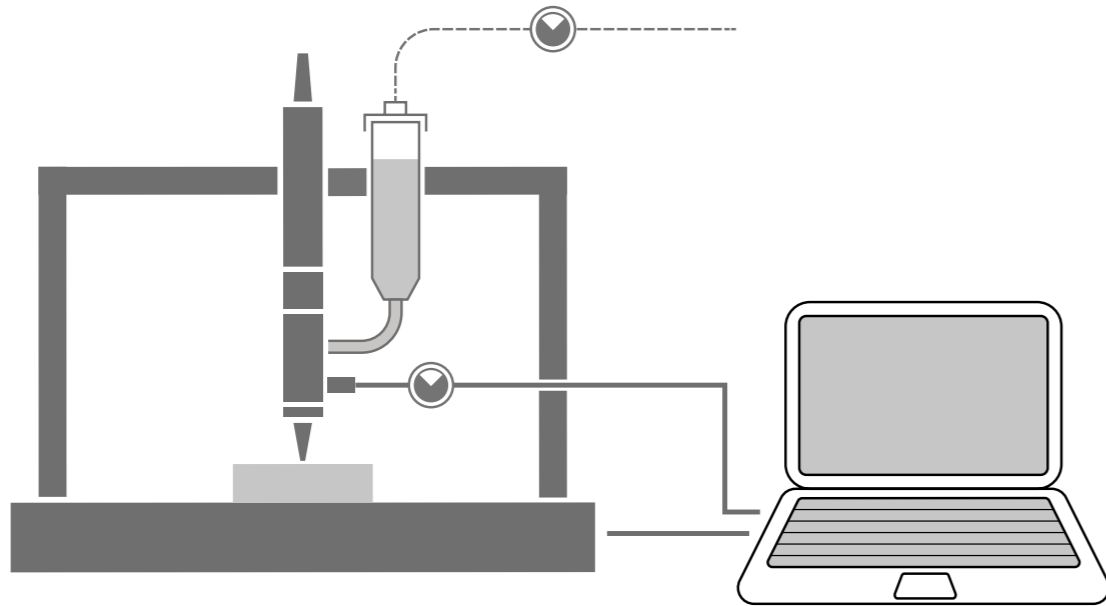

TWO OPTIONS FOR ACTUATION

Drive unit A:

Printhead is actuated via stepper motor driver

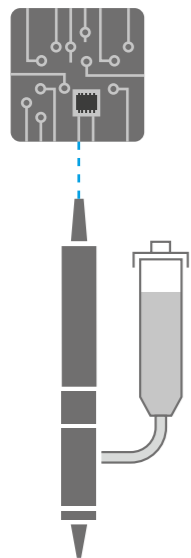

Drive unit B:

Printhead is actuated via STP/DIR signals of the board

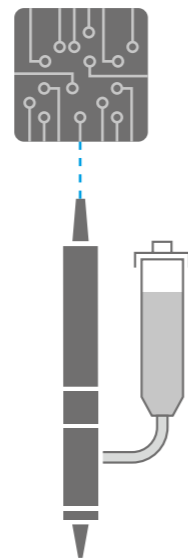

ACCESSORIES

PRESSURE SENSOR flowplus-SPT M6

- Measurement range pressure 0 – 40 bar
- Scaling output signal pressure 0.1 – 10 V DC (corresponds to 0 – 40 bar)
- Scaling of output signal temperature 0.5 – 5 V DC (corresponds to 5 – 50 °C)
- Power supply 24 V DC ± 10 %

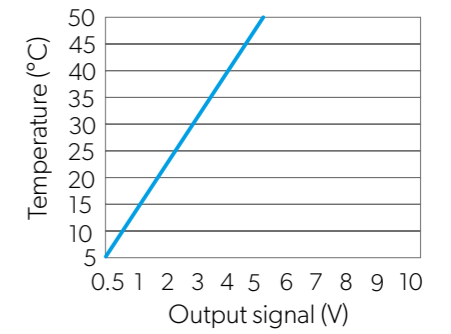
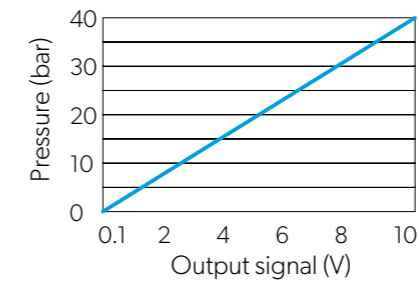

HIGH PRECISION NEEDLES

- Higher precision than standard dispensing needles
- Tapered tips for easy material flow
- Industrial Luer-Lock thread



STATIC MIXERS

- Suitable for a wide range of cartridge sizes and material ratios
- Reduces material waste
- Suitable for low, medium and high viscosity materials





MATERIAL EMPTYING AND TREATMENT

Efficient product handling during the emptying and supplying of 1- and 2-component fluids – including intuitive control technology. Our products are specially adapted to your material to be processed and integrated into your production process.

SYSTEMS FOR MATERIAL EMPTYING

Continuous and constant material supply for seamless production without interruptions.

Container volume: 30 ml – 1,000 l
Emptying capacity: individually customizable
Viscosities: up to 7,000,000 mPas



ViscoMT-C/-CM



ViscoMT-D



vipro-FEED



ViscoMT-XS

SYSTEMS FOR MATERIAL TREATMENT

Homogeneous, air- and bubble-free pastes and fluids for a reliable dosing process – buffering and degassing dosing material.

Container volume: 2.5 l / 3.5 l / 15 l / 25 l / 80 l
Withdrawal capacity: individually customizable
Viscosities: up to 2,000,000 mPas



ViscoTreat-Im



ViscoTreat-R



ViscoTreat-I



MODULAR SYSTEM

Based on our process know-how, your system is adapted individually to your process – including engineering and project management.

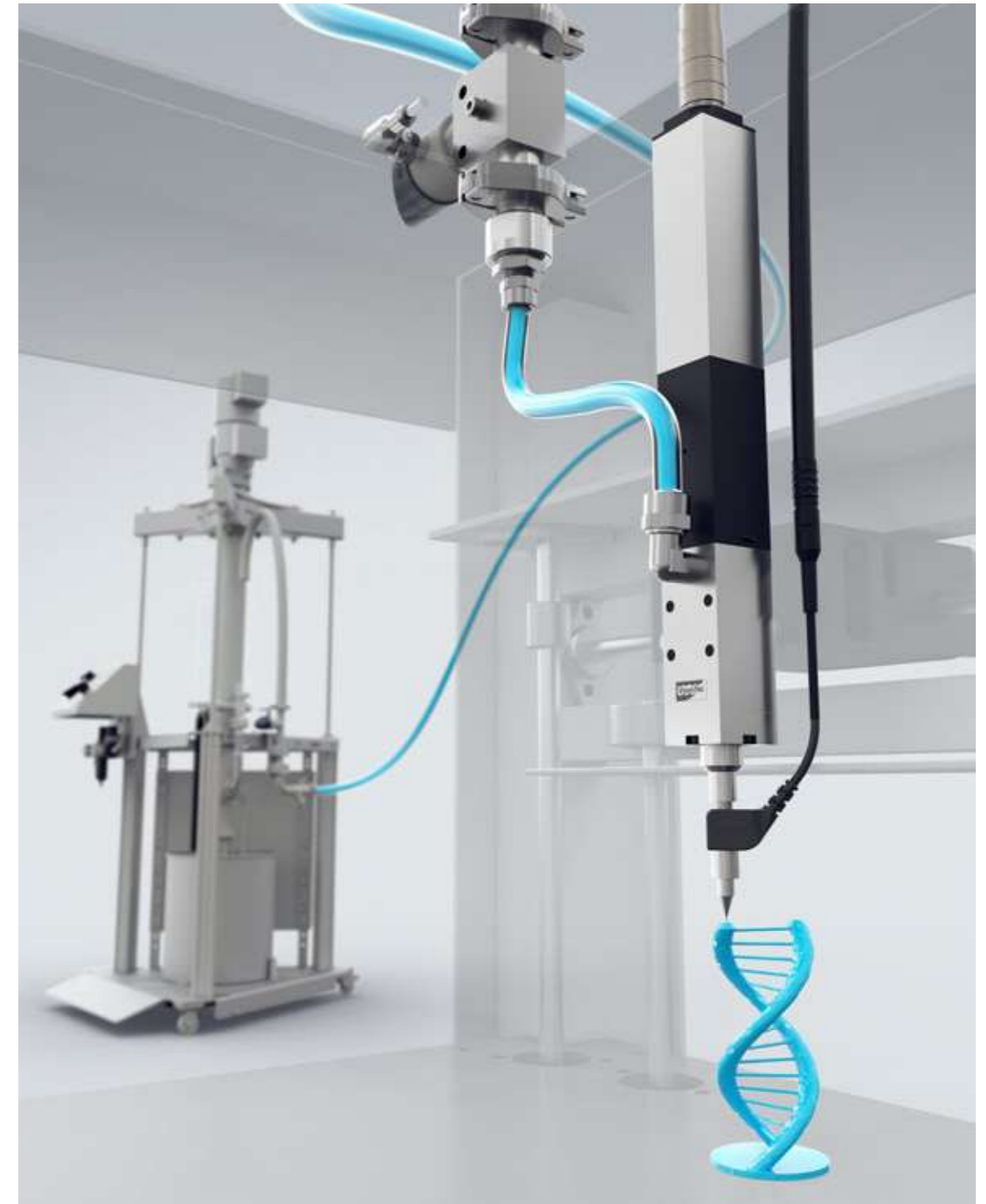

Emptying systems



Material treatment systems



3D print heads

VISCOTEC PUMPEN- U. DOSIERTECHNIK GMBH

Address: Amperstraße 13
84513 Töging a. Inn
Tel.: +49 8631 9274 0
E-mail: mail@viscotec.de
Web: www.viscotec.com

VISCOTEC AMERICA INC.

Tel.: +1 770 422 4281
E-mail: sales@viscotec-america.com
Web: www.viscotec-america.com

VISCOTEC ASIA PTE. LTD.

Tel.: +65 6569 3629
E-mail: sales@viscotec-asia.com
Web: www.viscotec-asia.com

VISCOTEC GREATER CHINA

Tel.: +86 21 6165 9002
E-mail: sales@viscotec-china.com
Web: www.viscotec.com.cn

VISCOTEC INDIA PVT. LTD.

Tel.: +91 20 4104 7135
E-mail: sales@viscotec-india.com
Web: www.viscotec-india.com

VISCOTEC FRANCE SASU

Tel.: + 33 5 56 17 64 36
E-Mail: sales@viscotec.fr
Web: www.viscotec.fr

VISCOTEC HONG KONG LIMITED

Tel.: +852 2593 1235
E-Mail: sales@viscotec-hongkong.com
Web: www.viscotec.com/hk

All data is supplied without liability | EN 10/23

FOLLOW US

